

SYMETRIX

nuovo

Full Module Door Station

2-Wire DT821

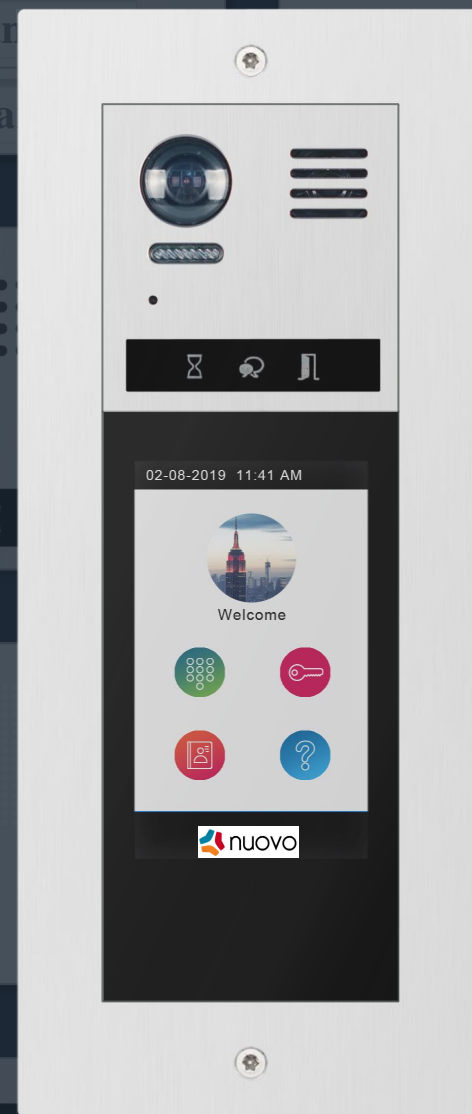

DT821

RFID/Pin code access
TFT Screen/Digital tube Display
Information board



Modularisation

Voice prompt
Language customisation



Voice Prompt



Modularise fixing

Plug and play

Easy Configure

IP54 water proof



Water-Proof

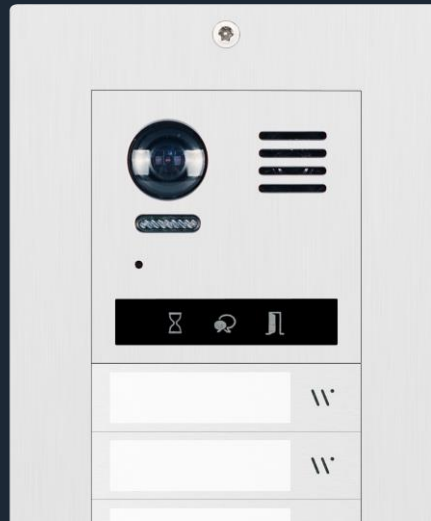

Stainless steel

304 Stainless Steel with
fingerprint-proof

Main Module

Essential Module

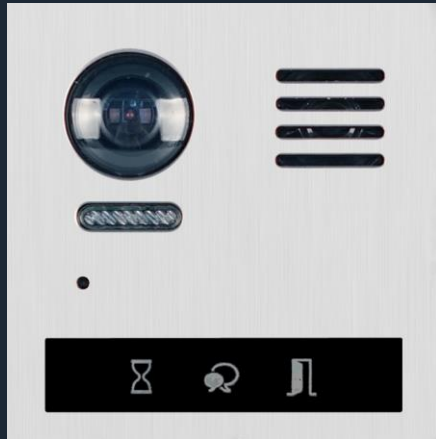

821-VD

170° Fisheye Camera

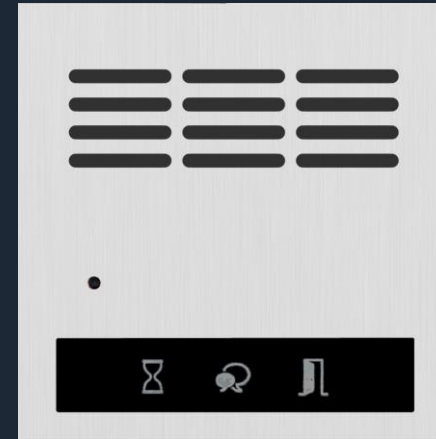

821-AD

Audio Only

Call Module

Calling modules

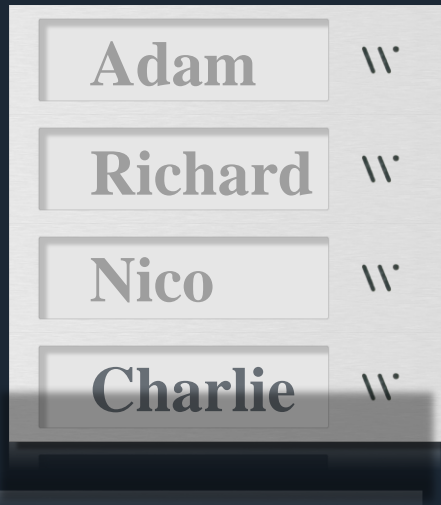

821-S4

- Metal touch calling button.
- Call button with name plate
- Name quick change by suction cup
- Optional blind cover (821-S0)



821-M4

- Mechanical calling button
- Fast change magnetic nameplate

Access Module

Access control module



821-MK

Password unlock
Up to 20 sets passwords
Mechanical Keypad
Call to monitor



821-FP

Fingerprint unlock
Up to 200 fingerprints
Semiconductor sensor

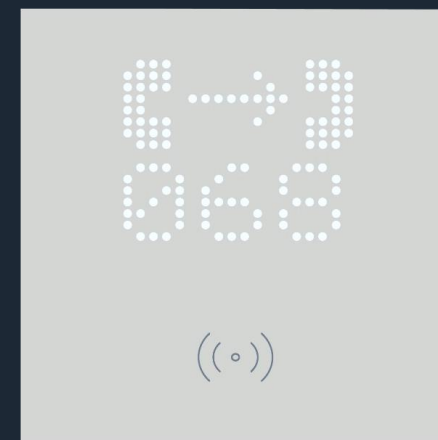

821-DR

Card unlock
Dot-Matrix display
125KHz & 13.56MHz Dual Standard
*Plexi-glass surface
*Dark-brown optional

Information Module

Display information module

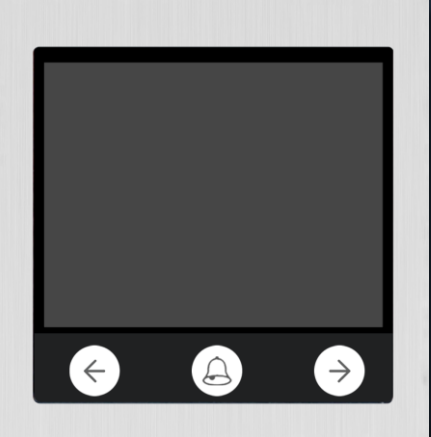

821-TFT

TFT Screen
Namelist
Logo/Info Display

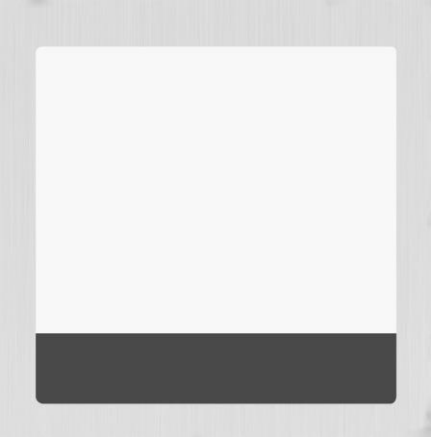

821-LB

Information Board with backlight



821-BL

Blank stainless steel
*Customisable laser printing text/logo/info

Integrated Module

Multi function module

5 Inch TFT touch screen

Full glass surface

Access card with both
12.5Khz and 13.65Mhz

Password unlock

Customisable menu

821-T5

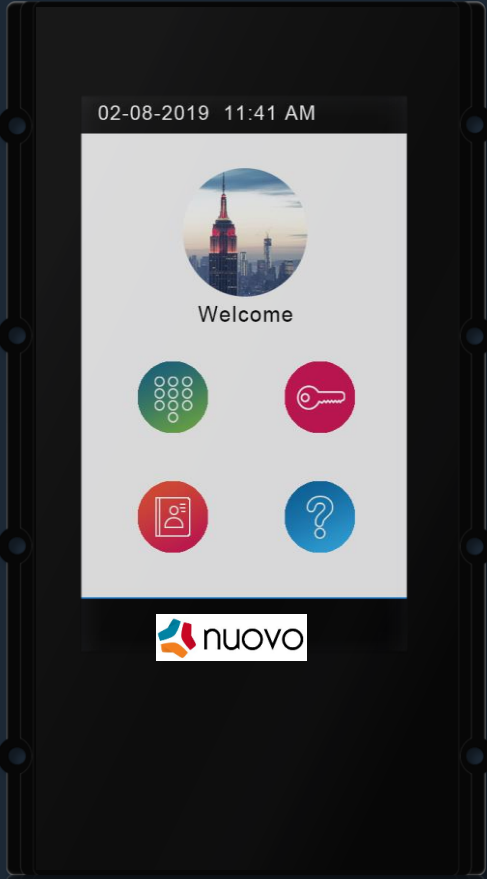

Frame & Mount Box

Flush or Surface



821 3x1-F

Flush Mount

Plastic in-wall mount box

Stainless steel Frame



821 3x1-S

Surface Mount

Aluminum built-in rain cover

Stainless steel box

Stainless steel Frame

2-Gang is available

Frame & Mount Box

Flush or Surface

821F-3X2

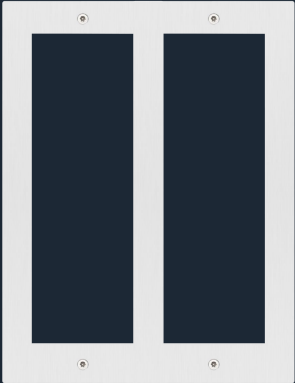

821F-3X1



821F-2X2

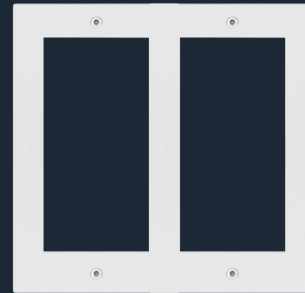

821F-2X1



821S-3X2



821S-3X1

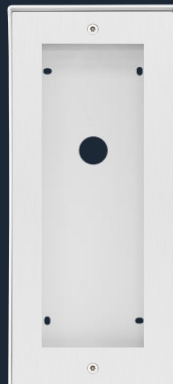

821S-2X2

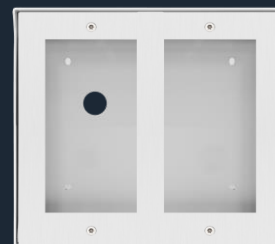

821S-2X1



Setup your DT821

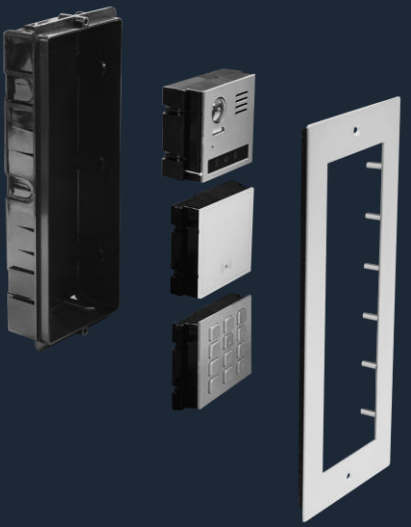

Main

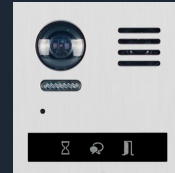

821-VD

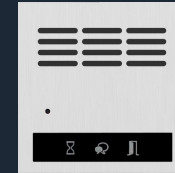

821-AD

Integrated



821-T5

Call

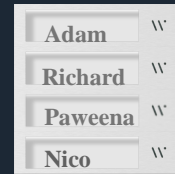

821-S4



821-M4

Access

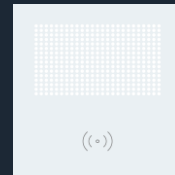

821-DR

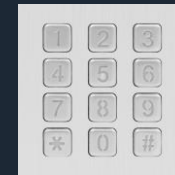

821-MK



821-FP

Info



821-TFT

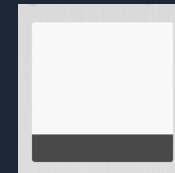

821-MK

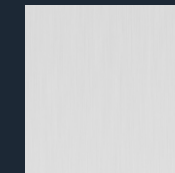

821-BL

Assembled



DT821/DK-F

Video with
Dot-Screen Card Unlock
4 Buttons



DT821/BS4-F

Video with
4 Buttons

Dimension

Surface Mount

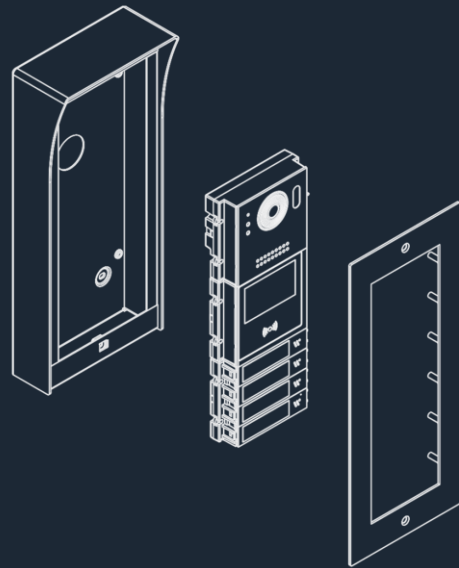
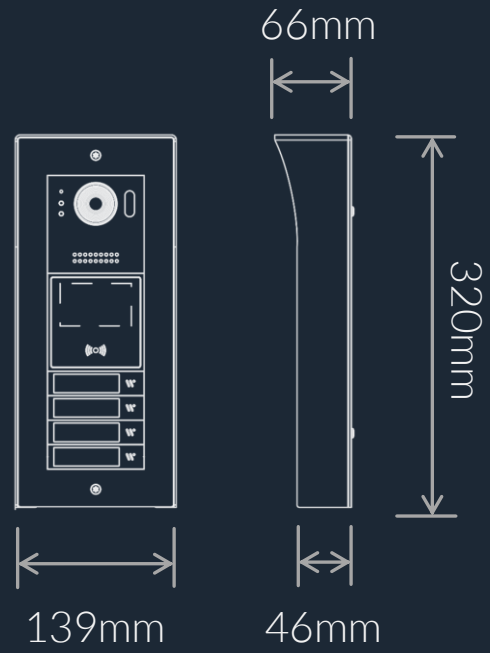

Flush Mount

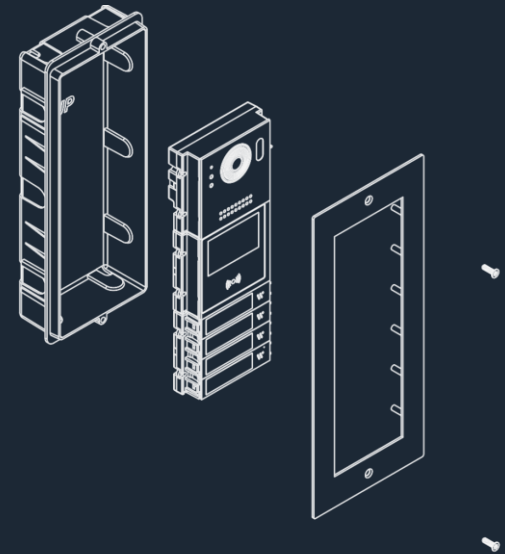
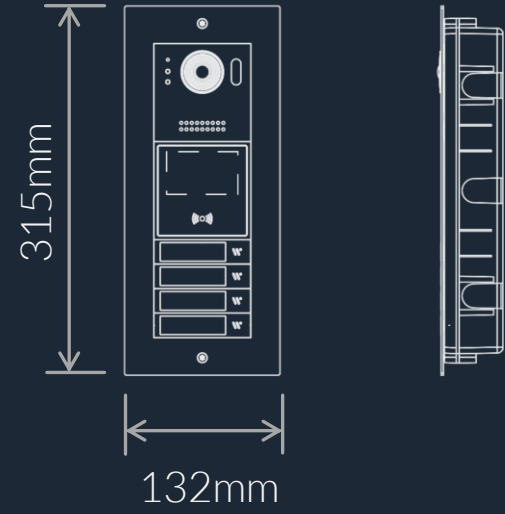

V-TEK

Distributed By

Symetrix Data & Security

Unit 29, 1 Wentworth Street Greenacre NSW2190

Phone: 1300 097 727 or +61 2 8733 4491

E: sales@symetrix.com.au

W: www.symetrix.com.au

