

2 WIRE INTERCOM SYSTEM

DT437-D4

4.3" COLOR TFT MONITOR



- Please read this manual carefully before using the product you purchase, and keep it well for future use.
- Please note that images and sketch maps in this manual may be different from the actual product.

1.Parts and Functions

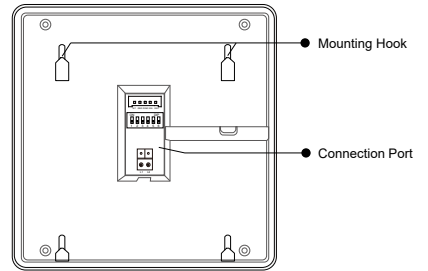
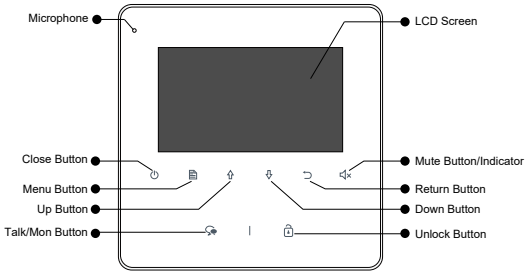

Terminal Description

SW+,SW-: Door bell call button connection port.

Ring,GND: Extra buzzer connection port.

NC: Reserved.

L1,L2: Bus terminal.

DIP switches: Total 6 bits can be configured.

Bit1~Bit5: Used to User Code setting.

Bit6: Video impedance matching switch.

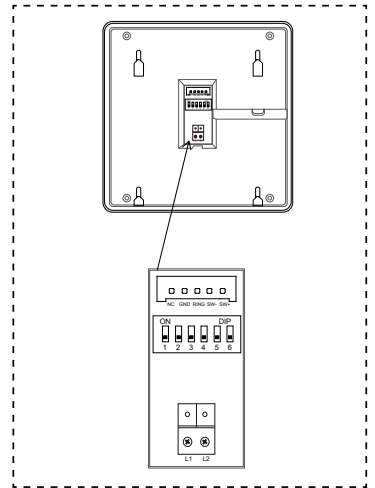

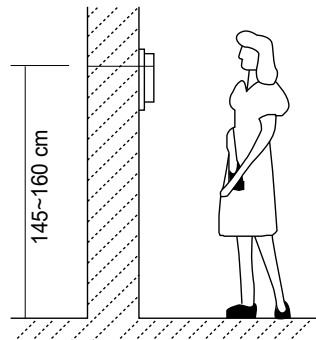
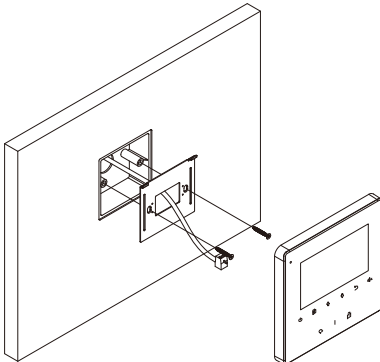

2.Monitor Mounting











1. Use the screws to fix the Mounting Bracket on the mounting box.(fitting accesories includes a Bracket (Two pieces of 4X25 screws are needed for fastening the Mounting Bracket), Special 2 wire connectors to connect with Monitor)
2. Wire the system correctly(see the later connection chapter) then hang the Monitor on the Mounting Bracket firmly.

3. Main Menu

Press  **Menu** /  **Close** button, in standby mode, the main menu page will be shown as follows:









4. Basic Door Release Operation

1. Press **CALL** button on outdoor station, the Monitor rings, meanwhile, the screen displays the visitors' image.
2. Press  **Talk/Mon** Button on monitor, you can communicate hands free with the visitor for 90 seconds. After finishing communication, press  **Talk/Mon** button again(or press  **Close** Button) to end the communication. If nobody answers the phone, the screen will be turned off automatically after 40 seconds.
3. During talking state, Press  **Unlock** Button to release the first door.
4. When the monitor is in standby mode, press  **Talk/Mon** Button (or select **Monitor By Select** button on main menu, press  **Menu** Button to confirm, and then it will enter the select a camera page, then you can use  /  Button to select the camera you want), the screen can display the view of outside.





5. Intercom Function

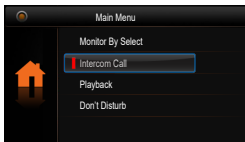

When the monitor is in standby mode, press  **Menu** Button to enter main menu page. Use  /  Button to move upward / downward to select **Intercom Call** item, press  **Menu** Button to enter the select intercom page, you have 3 items to select.

1. **Namelist Call:** User in one apartment can call other apartments in the system. the namelist will be created automatically by the system. Use  /  Button to select a name on the screen then press  **Menu** Button to call. (Note: 1. Press "MENU" button again to redial. 2. The DIP switches code of the monitors are not the same.)



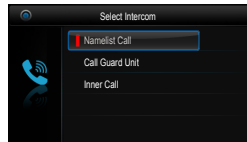

Use  /  button to select **Intercom Call** item, then press  **Menu** button to confirm.

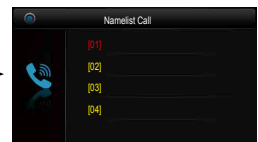

Use  /  Button to select **Namelist Call** item, then press  **Menu** button to confirm.





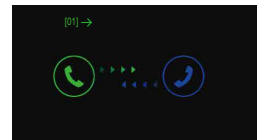

Use  /  Button to select the item you want, then press  **Menu** button to call.







Calling.

2. **Call Guard unit:** A Monitor can be assigned as Guard Unit Monitor; when the Guard Unit Monitor answers the call, conversation with the guard person is started.
3. **Inner Call:** If multi Monitors are installed in the same apartment, select Inner Call, all the other Monitors will ring at the same time, whichever Monitor answers the call, conversation is started, and the other monitors will stop ringing at the same time. (note: the DIP switches setting of all monitors must be same.)

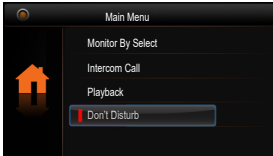

6. Don't Disturb Function

When the monitor is in standby mode, press  **Menu** Button to enter main menu page. Use  /  Button to move upward / downward to select **Don't Disturb** item, press  **Menu** Button (or press  **Mute** Button/Indicator directly) to enter the no disturb page, you have 4 items to select.



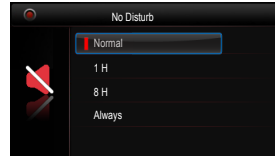



Use  /  button to select **Don't Disturb** item, then press  **Menu** button to confirm.





Use  /  Button to select the item you want, then press  **Menu** button to confirm.

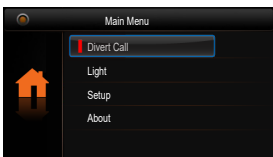

7. Divert Call Function

When the monitor is in standby mode, press  **Menu** Button to enter main menu page. Use  /  Button to move upward / downward to select **Divert Call** item, press  **Menu** Button to enter the divert options page, you have 3 items to select.

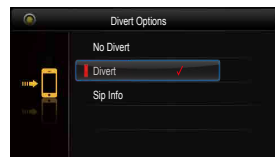

Use  /  button to select **Divert Call** item, then press  **Menu** button to confirm.



Use  /  Button to select the item you want, then press  **Menu** button to confirm.

1. **No Divert**----calls from outdoor station will not be diverted.
2. **Divert**

Two modes can be selected.

* When the divert function is activated and the don't disturb function is turned off, the divert mode is **Divert, If No Answer**.

*When both the divert function and the don't disturb function are activated, the divert mode is **Divert, immediately**.

3. **Sip Info**----Select this item to view the Sip information and get QR code, press  **Menu** button could change password.

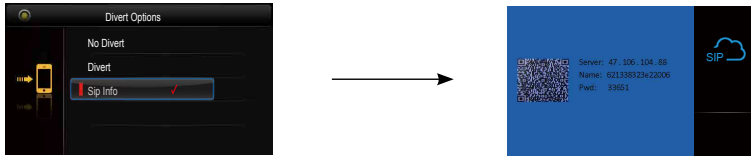

8.Download Setup 2Easy APP

1. Scan and download 2Easy APP, or search “2Easy” on APP store.

IOS



Android



2. Permit “2Easy” with internet access and camera, on monitor, in “Divert” -> "SIP Info" , and keep in "SIP Info" page. on 2Easy APP, press on top-right, to scan QR code on monitor, and press “Save” .

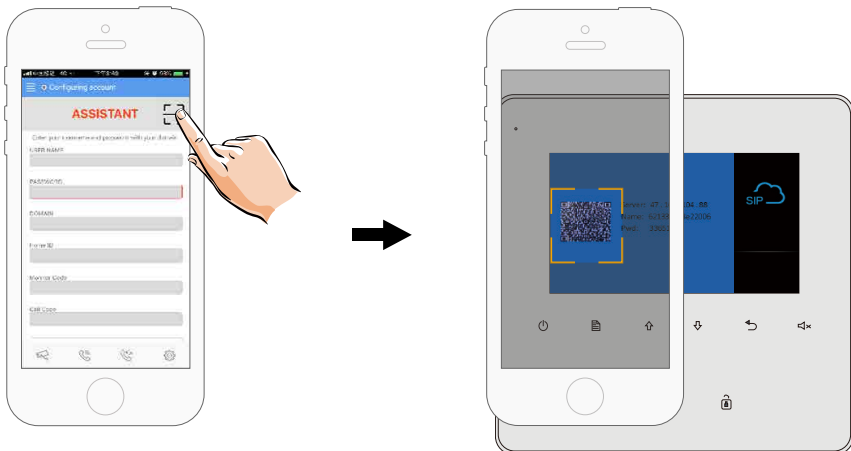

3. Disable “IPV6” on 2Easy APP

Most of internet provide doesn't support IPV6 feature, please manually disable it with follow steps:

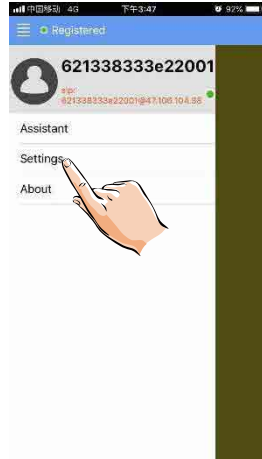

4. After login SIP account on 2Easy APP, check on status bar, or press on the “Registered” area to manually register, until 2Easy APP display:

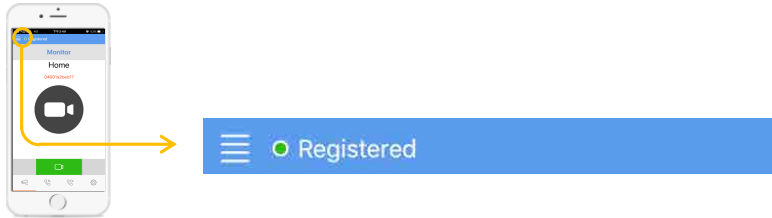



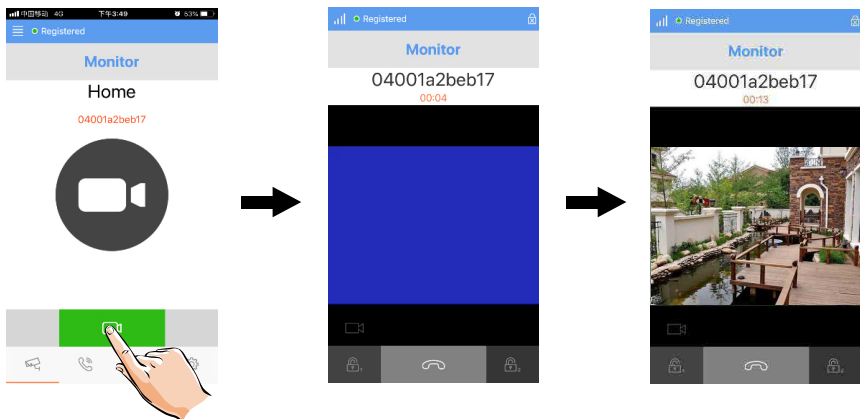

9. Surveillance door station via 2Easy APP

On 2Easy APP, press on “Monitor” and wait for a few second (Due to 2-Wire communication will take around 12 second to get video), blue screen is normally due to the monitor is verifying the password and monitor code.





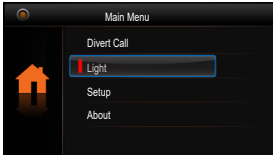

10.Light Function

When the monitor is in standby mode, press  **Menu** Button to enter main menu page. Use  /  Button to move upward / downward to select **Light** item, press  **Menu** Button to enter the light Option page, you have 3 items to select.

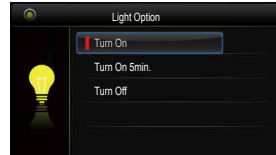

Use  /  button to selete **Light** item, then press  **Menu** button to confirm.







Use  /  Button to selete the item you want, then press  **Menu** button to confirm.

1. **Turn On**: Select it to open the staircase light, the staircase light will be turned off automatically after 60 seconds.
2. **Turn On 5min**:Select it to open the staircase light, the staircase light will be turned off automatically after 5min.
3. **Turn Off**:Select it to close the staircase light.

Note: the staircase light function will be activated only when the system connect light via DT-RLC module, otherwise, this function is unvalid in normal. For more information, please refer to DT-RLC user instruction in detail.

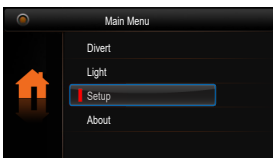

11.Setup Function

When the monitor is in standby mode, press  **Menu** Button to enter main menu page. Use  /  Button to move upward / downward to select **Setup** item, press  **Menu** Button to enter the user setup page, you have 4 items to select.

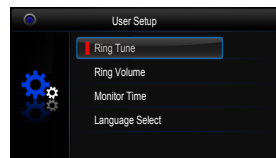

Use  /  button to selete **Setup** item, then press  **Menu** button to confirm.



Use  /  Button to selete the item you want, then press  **Menu** button to confirm.

1. **Ring Tune**: Select it to set the tune of Door Station, Intercom and Door Bell.
2. **Ring Volume**: Select it to set the volume of monitor.
3. **Monitor Time**: Select it to set monitor time.
4. **Language Select**: Select it to set the language.

12. Monitor Parameter Setting

12.1 How to enter the installation setting page

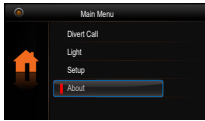

Use \uparrow / \downarrow button to select **About** item, then press Menu button to confirm.

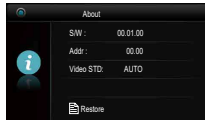

Press Unlock button and hold for 3s.

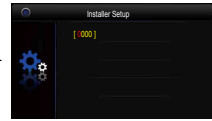

Use \uparrow / \downarrow button to increase/decrease the value you want, and press Menu button to confirm.

12.2 Restore to Default

Press Menu Button to enter the restore page, and then press Menu Button to confirm.

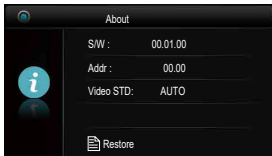

Press Menu button to enter the restore page.



Press Menu button to confirm.

12.3 The setting code and items

Code	Setting Item	Code	Setting Item
2419	Project Initialize	8018-8020	Video Display Standard
2500-2549	RM Parameter Set	8401-8499	Unlock Time
8000-8003	Setting master/slave monitor	9004-9005	United Door Ring or not
8004-8005	Guard Unit Enable	9015-9016	Intercom On/Off
8006-8007	Panel on/off as slaver called	9017-9018	Doctor Function On/Off
8010-8011	Unlock Mode:Close/Open	9020-9021	Hearing Aid(T-coil) On/Off
8016-8017	Bypass Enable/Disable		

12.4 How to set the monitor as a Guard Monitor

A Monitor can be assigned as Guard Unit Monitor; when the Guard Unit Monitor answers the call, conversation with the guard person is started..

The code number of 8004 is used to set the monitor as a guard unit monitor and 8005 is used to cancel this function.

12.5 How to set the slave monitor address

Maximum 4 monitors can be connected in one apartment, one master monitor together with 3 slave monitors, so you should set the address correctly. (note: must have one monitor to be set as master monitor)

The code of 8000 is used to set the master monitor.

The code of 8001 is used to set the first slave monitor.

The code of 8002 is used to set the second slave monitor.

The code of 8003 is used to set the third slave monitor.

12.6 How to set the monitor panel on

In default mode, when receive a calling, the master and slave monitors will ring at the same time, and just the master monitor can display the image while the slave monitors can not. But the settings can be changed, you can set the master monitor and all the slave monitors to panel on at the same time when receiving a call, just input the code number of 8006 on each slave monitor.

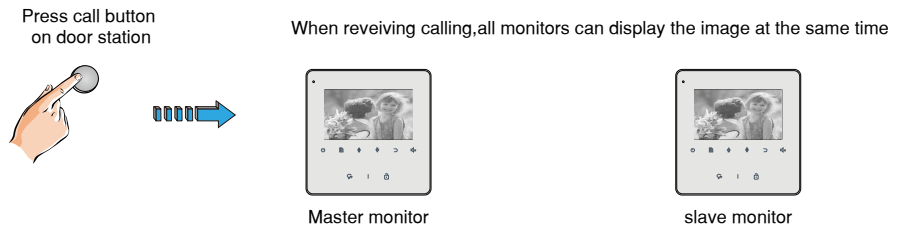

12.7 How to set the unlock parameter

Unlock mode:

There are two unlock modes: 1. power-on-to-unlock type: unlock mode=0 (by default)
2. power-off-to-unlock type: unlock mode=1.

The code number of 8010 is used to set the unlock mode to 0

The code number of 8011 is used to set the unlock mode to 1

Unlock time:

The unlock time can be changed by yourself at any time. It can be set from 1 to 9 seconds. The code number from 8021 to 8029 are used to set the unlock time to 1~9 seconds.

12.8 User Code Setup

In the DT system, every apartment must have a unique identification called User Code. The DIP switches are used to configure the User Code for each Monitor.

- Bit-1 to Bit-5 are used to User Code setting. The value is from 1 to 32, which have 32 different codes for 32 apartments.
- When multi Monitors are installed in one apartment, these Monitors have to use the same User Code setting, and the Master/Slave mode should be set on the Monitor.
- Bit-6 is line terminal switch, which have to be set to ON if the Monitor is in the end of the line (bus), otherwise set to OFF. The end of the line is terminal that no other section will start from it.

Bit-6 line terminal setting:





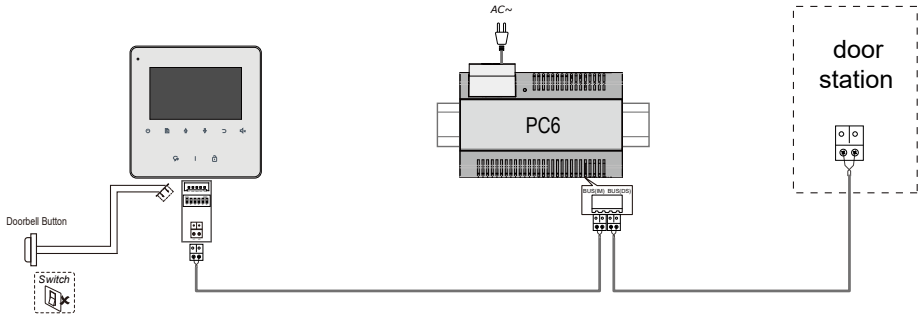

Bit state	Setting	Bit state	Setting
	Monitor not at the end of the line.		Monitor at the end of the line.

Bit state	User Code	Bit state	User Code	Bit state	User Code
	Code=1		Code=12		Code=23
	Code=2		Code=13		Code=24
	Code=3		Code=14		Code=25
	Code=4		Code=15		Code=26
	Code=5		Code=16		Code=27
	Code=6		Code=17		Code=28
	Code=7		Code=18		Code=29
	Code=8		Code=19		Code=30
	Code=9		Code=20		Code=31
	Code=10		Code=21		Code=32
	Code=11		Code=22		

13. Basic Connection



14. Screen and Volume Adjustment

During monitoring or talking, press  **Menu** Button, the *ADJUST MENU* will be displayed. Use  **Menu** Button to select the adjustment item; use  /  Button to decrease / increase the value, press  **Return** Button to quit the adjust page.

1. Total 4 screen modes can be selected in sequence: *Contrast, Bright, Color* and *Volume*.
2. The *Bright* and *Color* item is for the image quality setting, adjust the value to get the best image you like.
3. The *Volume* items are ring tone and talking volume adjustment.



15. Specifications

- Power supply for indoor monitor: DC 20~28V
- Power consumption: Standby 0.17W; Working status 4.7W
- Monitor screen: 4.3 inch digital color TFT
- Display Resolutions: 480(R, G, B) x 272 pixels
- Video signal: 1Vp-p, 75Ω, CCIR standard
- Wiring: 2 wires, non-polarity
- Monitor time: 40 seconds
- Talking time: 90 seconds
- Dimensions: 137(H) × 137(W) × 17(D)mm

The design and specifications can be changed without notice to the user. Right to interpret and copyright of this manual are preserved.